

# LED DISPLAYS

U.S.Electronics Inc.

Ph:(314)423 7550

CM2 - 056XX00

Fax:(314)423 0585

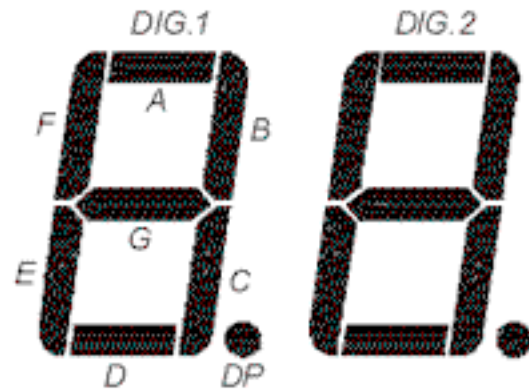
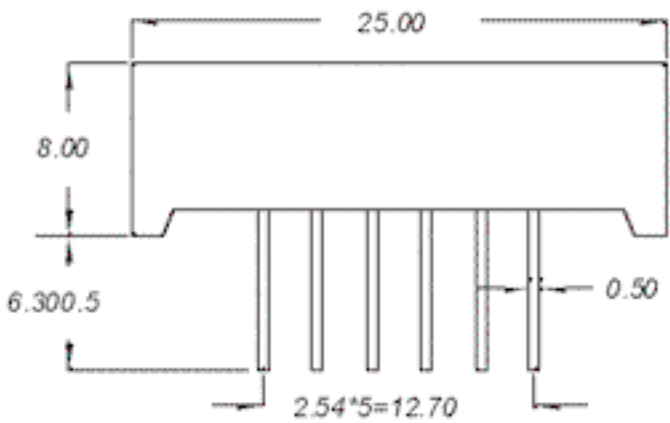
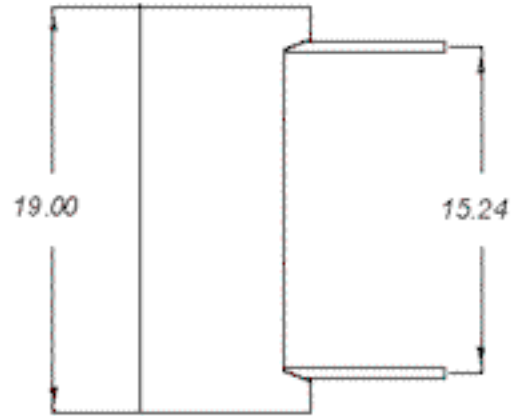
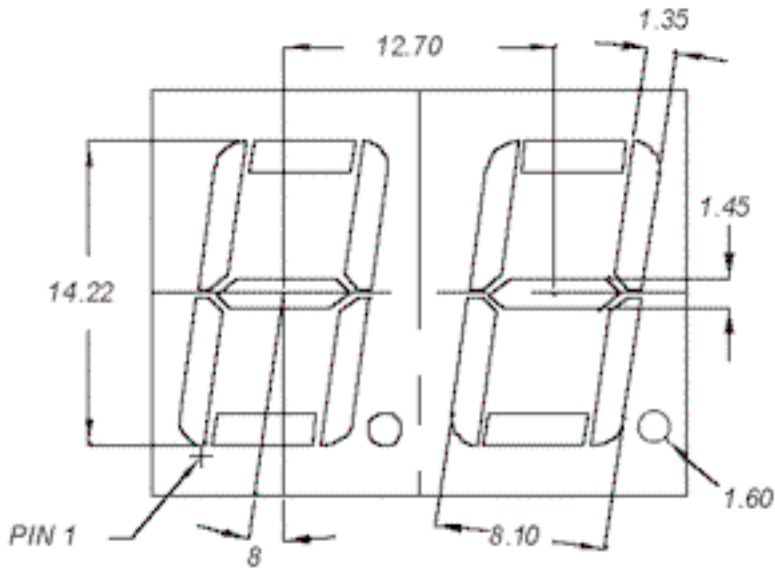



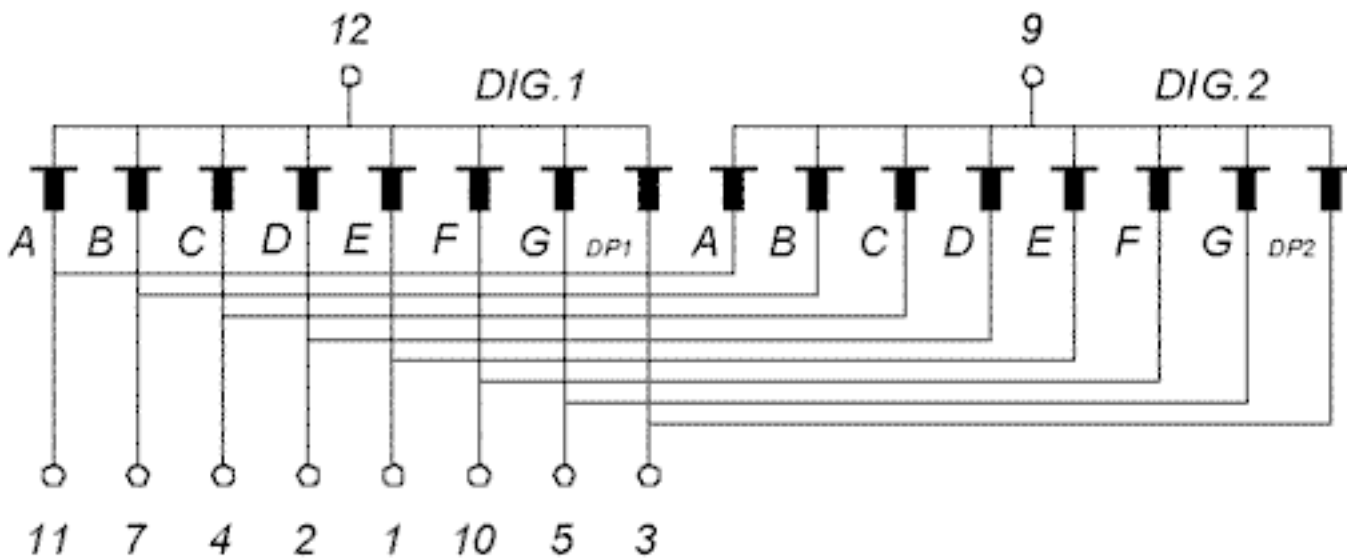







6 NO CONNECT  
8 NO CONNECT

- |                   |                          |
|-------------------|--------------------------|
| 1. ANODE E        | 7. ANODE B               |
| 2. ANODE D        | 8. NO CONNECT            |
| 3. ANODE DP1, DP2 | 9. COMMON CATHODE DIG.2  |
| 4. ANODE C        | 10. ANODE F              |
| 5. ANODE G        | 11. ANODE A              |
| 6. NO CONNECT     | 12. COMMON CATHODE DIG.1 |

Part Numbers		Emitting Color		IF=20mA Min. ~ Typ.
COMMON CATHODE	COMMON ANODE			
CM2 - 0565200	CM2 - 0566200	Green		0.87 - 2.40
CM2 - 0565300	CM2 - 0566300	Orange		0.87 - 2.40
CM2 - 0565400	CM2 - 0566400	Gap-Red		0.34 - 0.95
CM2 - 0565500	CM2 - 0566500	Hi-Effi		0.87 - 2.40
CM2 - 0565600	CM2 - 0566600	Yellow		0.87 - 2.40
CM2 - 0565L00	CM2 - 0566L00	GaAlAs Red		2.40 - 6.00
CM2 - 0565G00	CM2 - 0566G00	SB/Green		1.70 - 4.80